

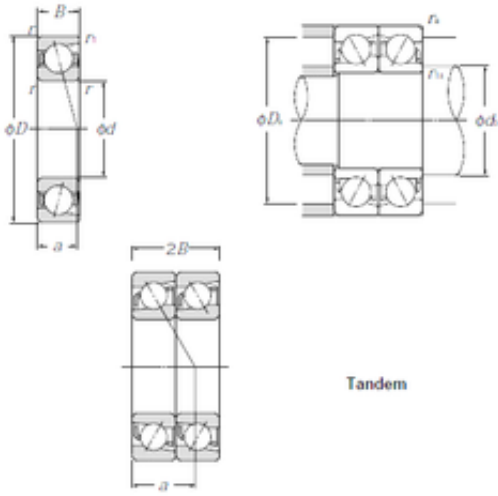

NACHI BEARINGS TRAINING INDUSTRY



75 mm x 105 mm x 16 mm CYSD 7915DT
angular contact ball bearings

Bearing No. 7915DT

Size	75x105x16 mm
Bore Diameter	75 mm
Outer Diameter	105 mm
Width	16 mm
d	75 mm
D	105 mm
B	16 mm
C	16 mm
Angle ()	25 °
r min.	1 mm
2B	32 mm
Weight	0,84 Kg
Basic dynamic load rating (C)	43 kN
Basic static load rating (C0)	54 kN
(Grease) Lubrication Speed	5000 r/min

7915DT Bearing 2D drawings and 3D CAD models