

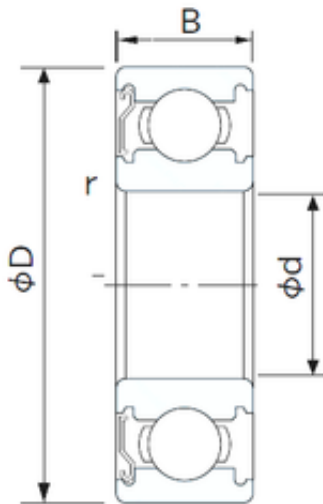

NACHI BEARINGS TRAINING INDUSTRY



15,875 mm x 44,45 mm x 12,7 mm CYSD
1633-Z deep groove ball bearings

Bearing No. 1633-Z

Size	15.875x44.45x12.7 mm
Bore Diameter	15,875 mm
Outer Diameter	44,45 mm
Width	12,7 mm
d	15,875 mm
D	44,45 mm
B	12,7 mm
C	12,7 mm
r min.	0,6 mm
Weight	0,1 Kg
Basic dynamic load rating (C)	9,38 kN

1633-Z Bearing 2D drawings and 3D CAD models