

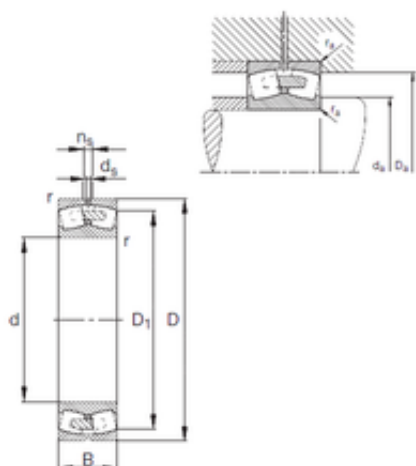

NACHI BEARINGS TRAINING INDUSTRY



600 mm x 870 mm x 200 mm FAG 230/600-E1A-MB1 spherical roller bearings

Bearing No. 230/600-E1A-MB1

Size	600x870x200 mm
Bore Diameter	600 mm
Outer Diameter	870 mm
Width	200 mm
d	600 mm
D	870 mm
B	200 mm
C	200 mm
n	23,5 mm
r min.	6 mm
D1	793,3 mm
da min.	623 mm
Da max.	847 mm
ra max.	5 mm
d5	12,5 r/min
Weight	399 Kg
Basic dynamic load rating (C)	6300 kN
Basic static load rating (C0)	11500 kN
Fatigue load limit (Pu)	880
Reference speed	425 r/min
Limiting speed	940 r/min
Calculation factor (e)	0,2
Calculation factor (Y0)	3,23
Calculation factor (Y1)	3,31
Calculation factor (Y2)	4,92

230/600-E1A-MB1 Bearing 2D drawings and 3D CAD models



NACHI BEARINGS TRAINING INDUSTRY