

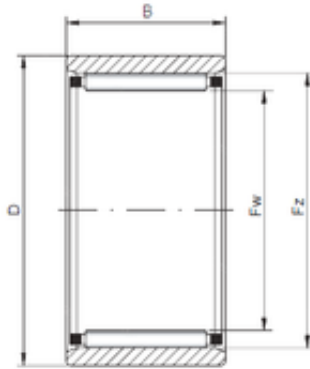

# NACHI BEARINGS TRAINING INDUSTRY

18 mm x 30 mm x 24 mm ISO RNAO18x30x24 cylindrical roller bearings



Bearing No. RNAO18x30x24

Size	18x30x24 mm
Bore Diameter	18 mm
Outer Diameter	30 mm
Width	24 mm
d	18 mm
Fw	18 mm
D	30 mm
Ew	24 mm
B	24 mm
C	24 mm

RNAO18x30x24 Bearing 2D drawings and 3D CAD models